

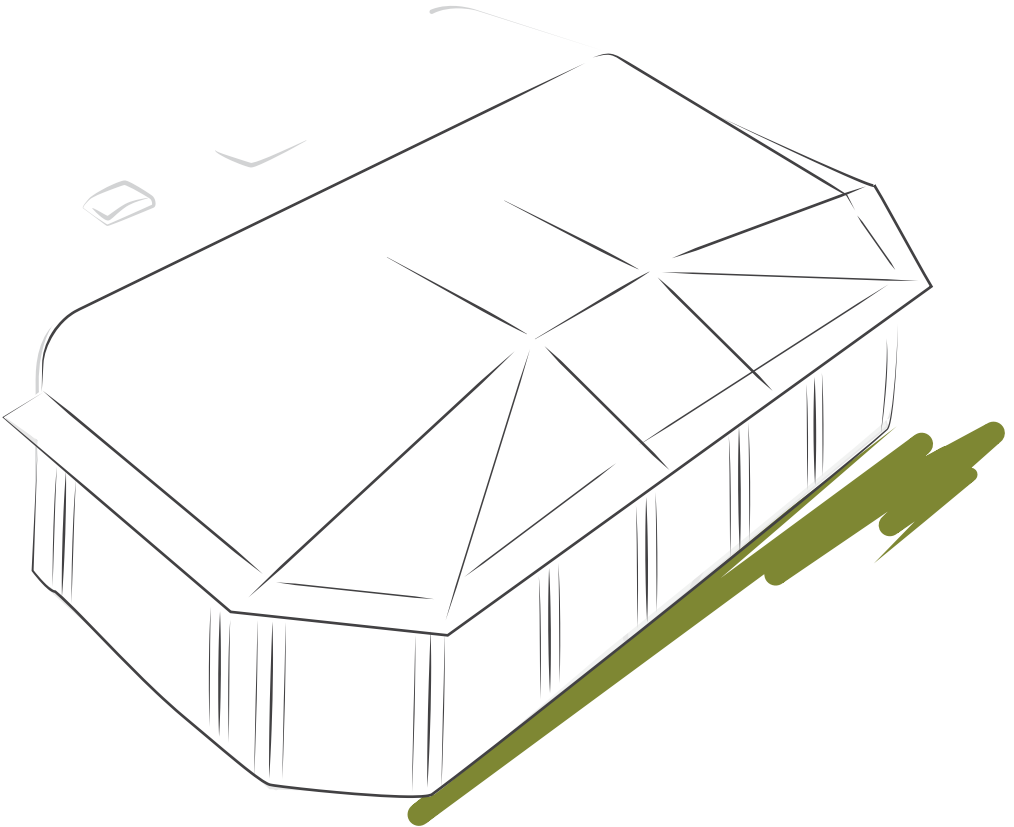

Penta Mega G25

MON008 V1 2016



FEEL FREE

1 x CMH

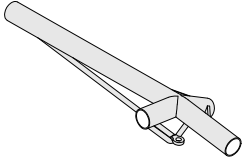

1 x CMV

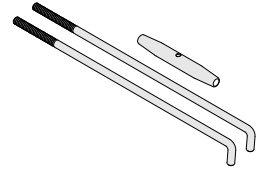
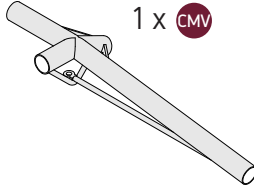

4 x CMF

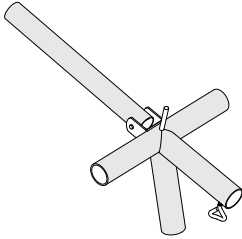

2 x C

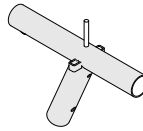

2 x CF

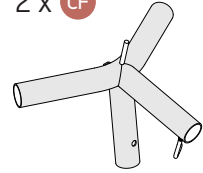

4 x AM



2 x A



5 x AX

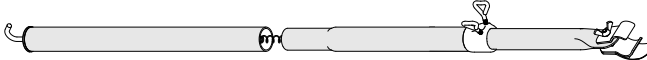

8 x B

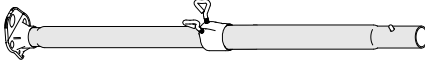

2 x CB

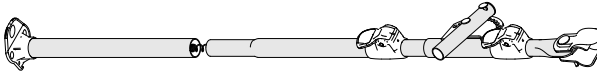

2 x S



2 x F

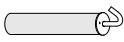

2 x FB



2 x FM



4 x FF



2 x FG

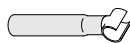

1 x



2 x CE

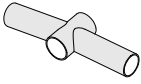

4 x AMF



2 x AF

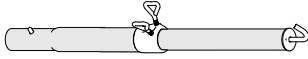

5 x EF



2 x EM

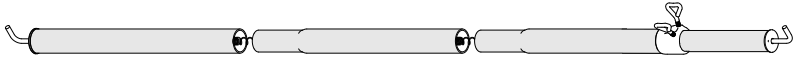

2 x E



2 x G



2 x GG



1 x GM



2 x GF



2 x GA



SV



V



1

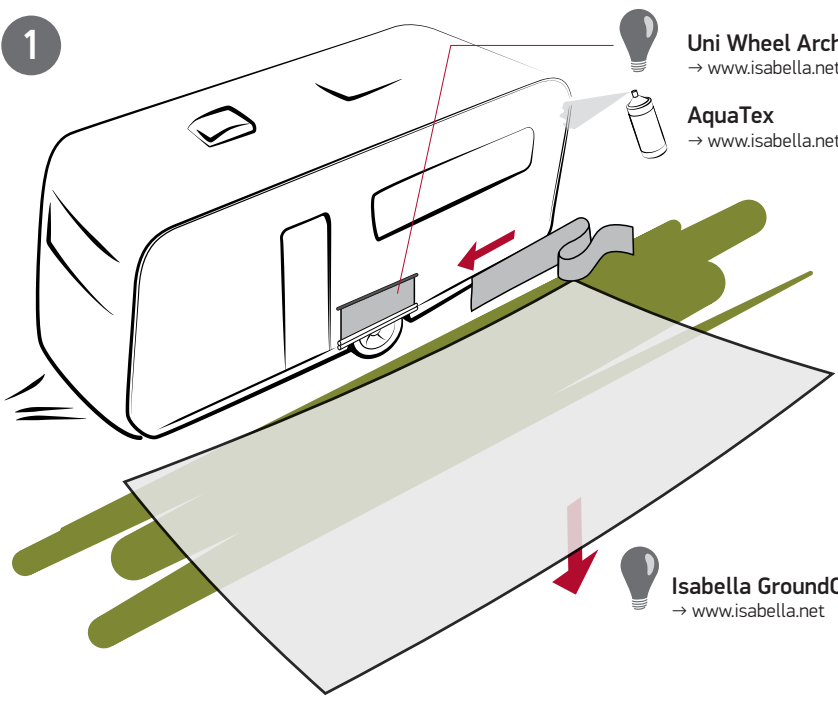

Uni Wheel Arch Cover
→ www.isabella.net

AquaTex
→ www.isabella.net

Isabella GroundCover
→ www.isabella.net

2

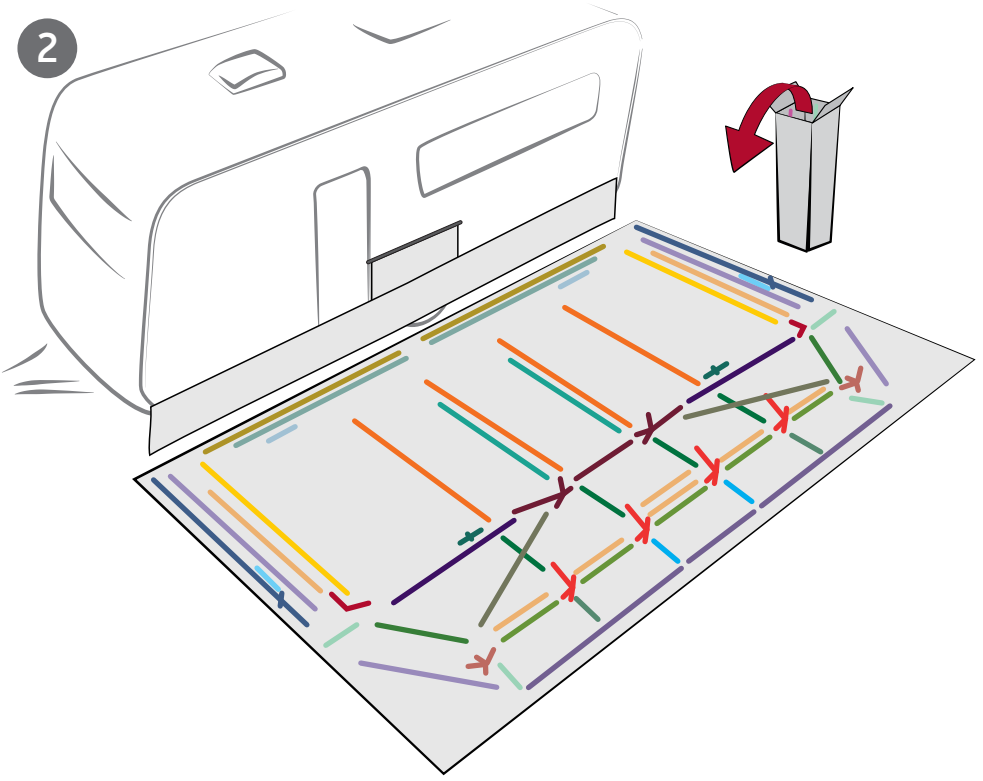

3

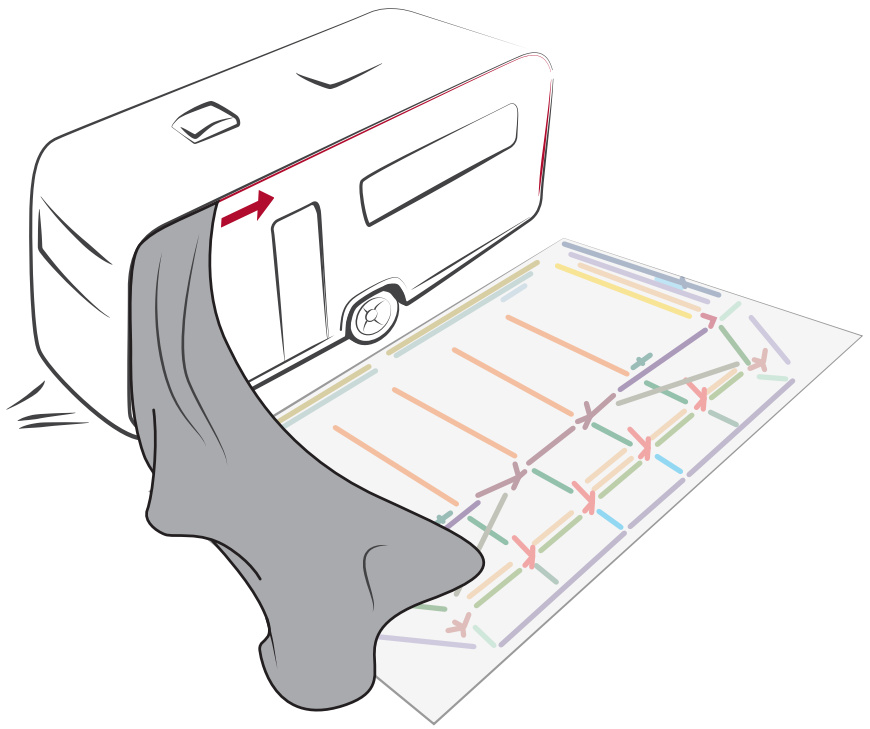

4

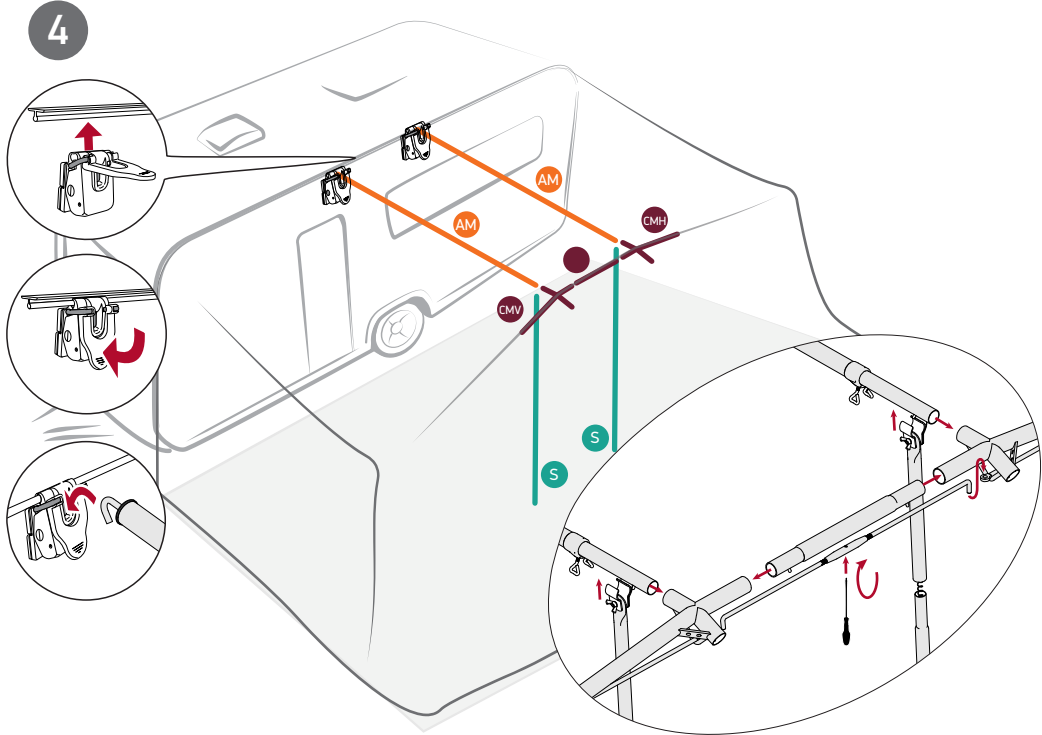

5

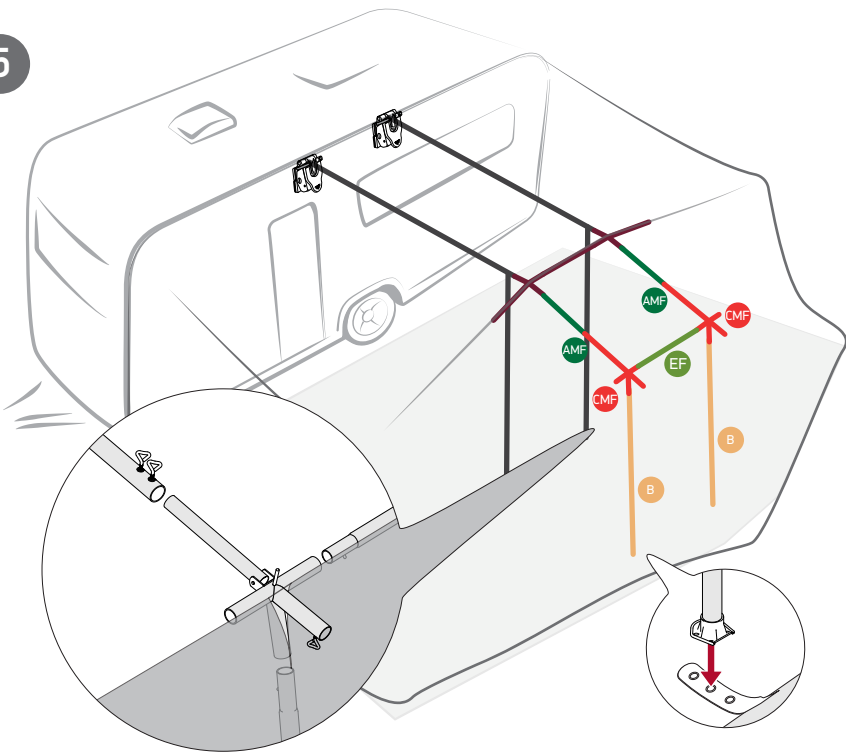

6

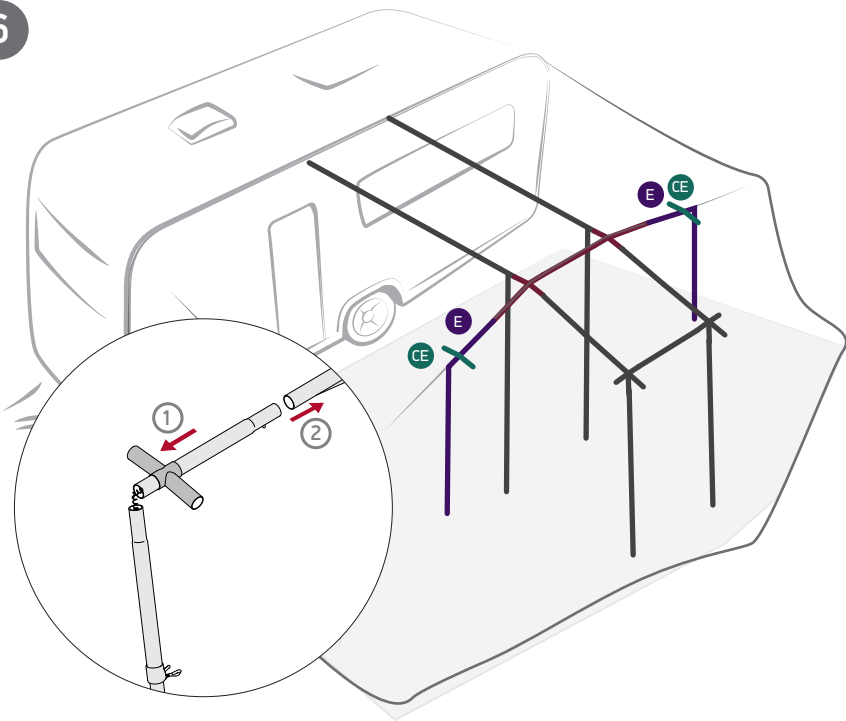

7

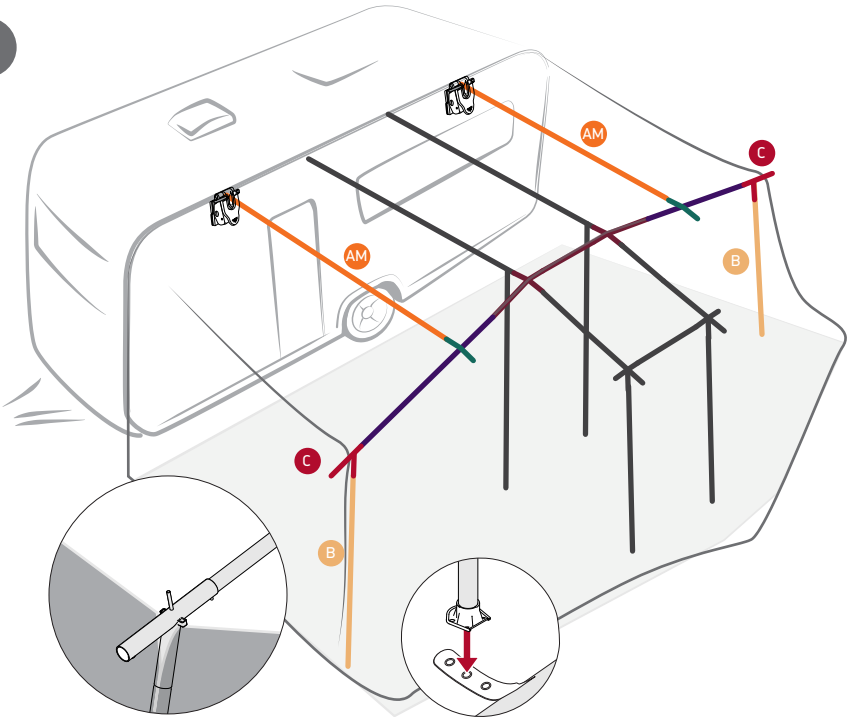

8

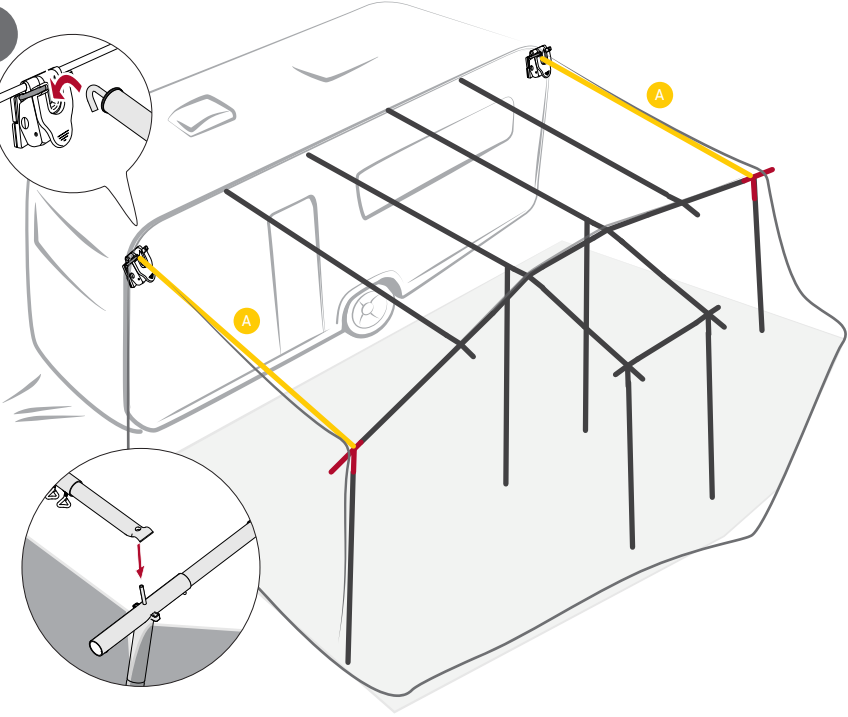

9

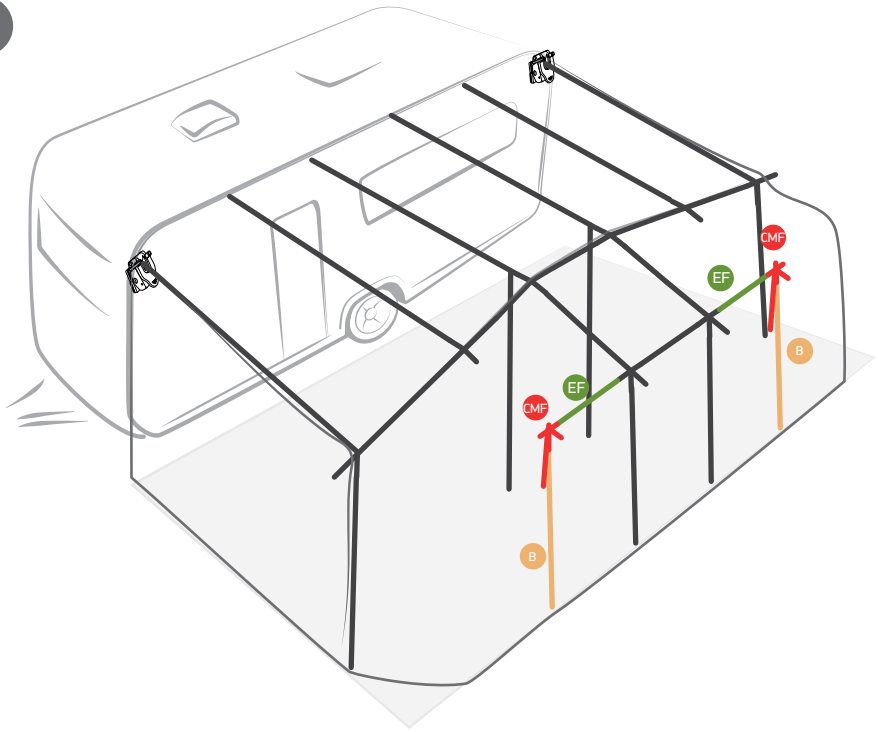

10

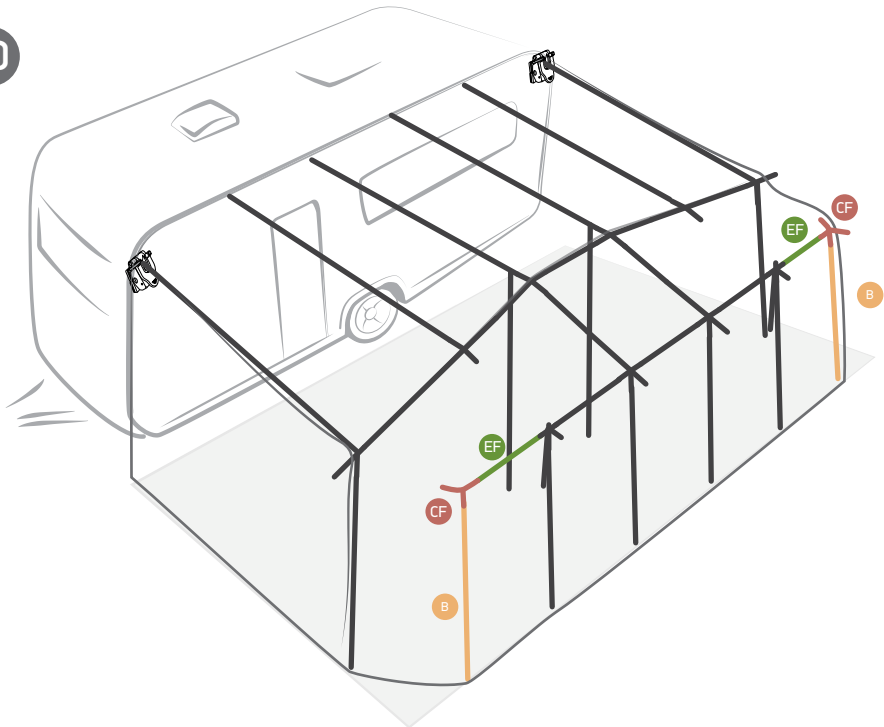

11

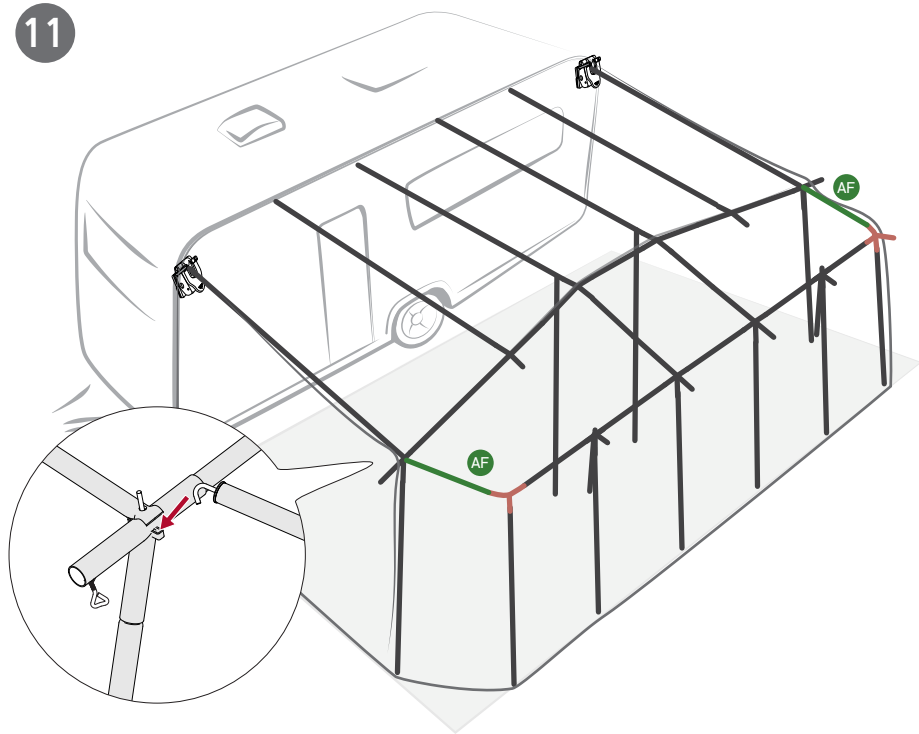

12

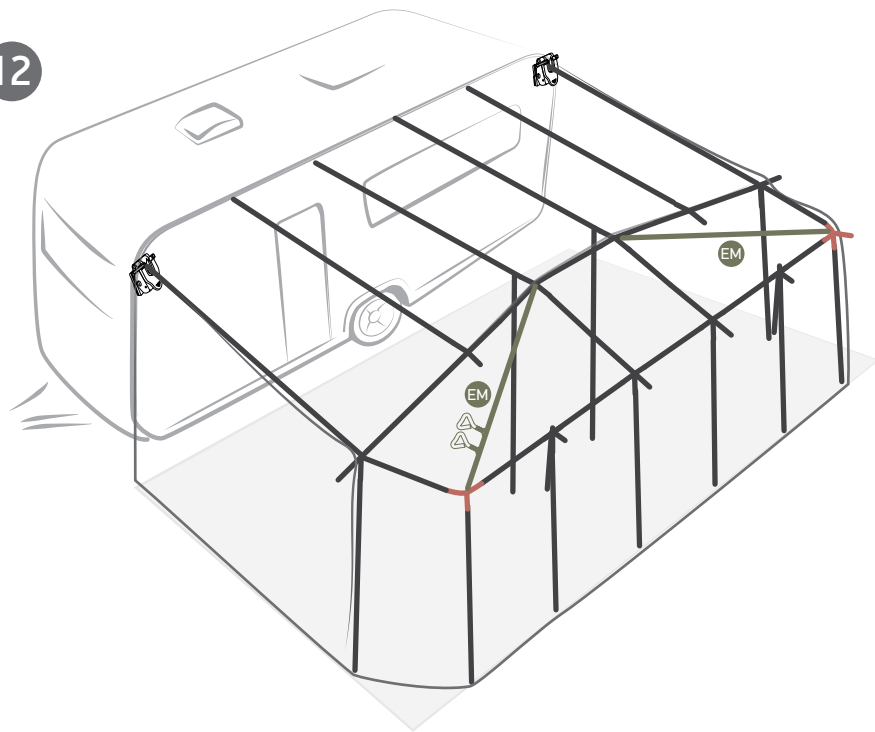

13

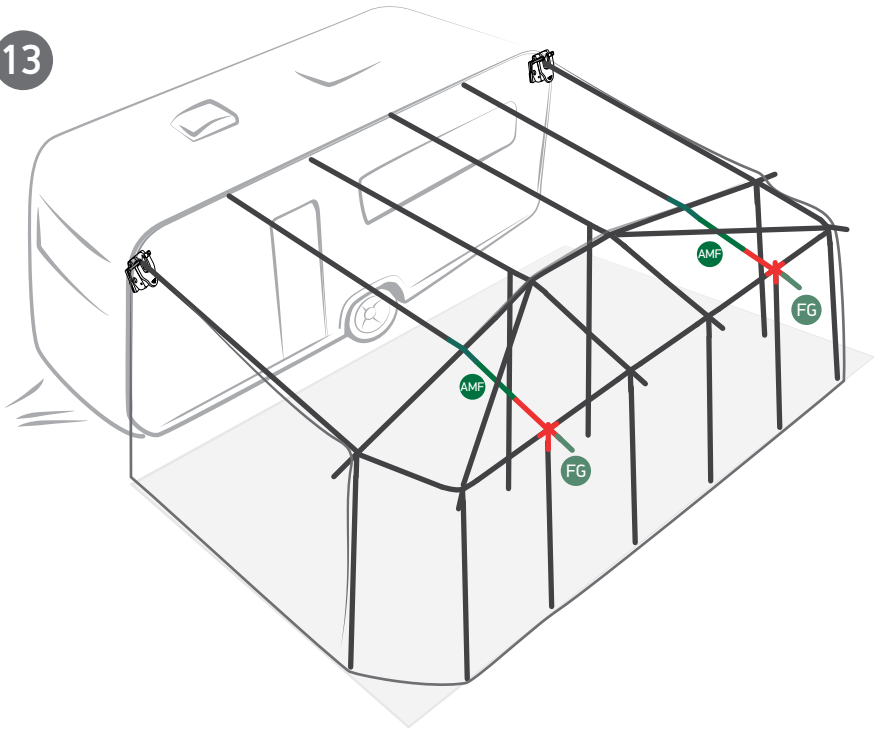

14

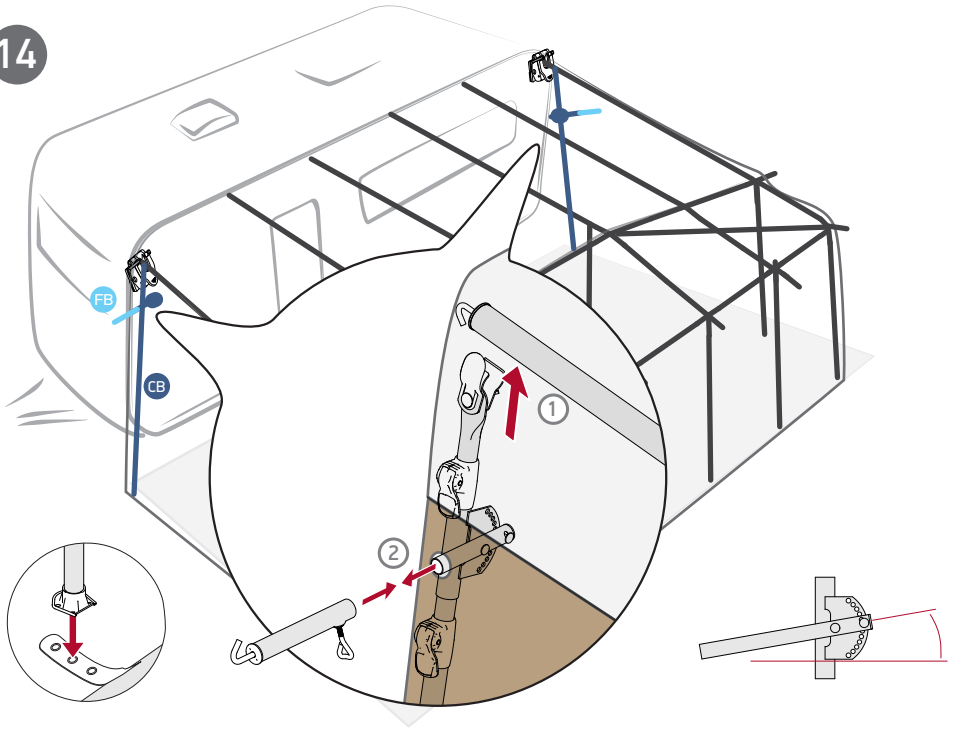

15

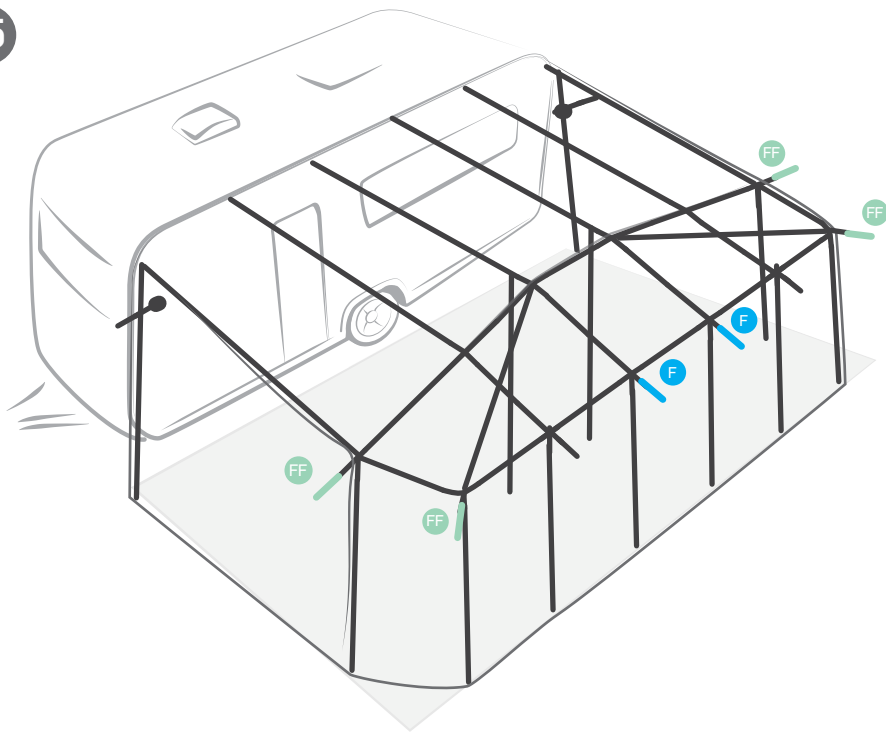

16

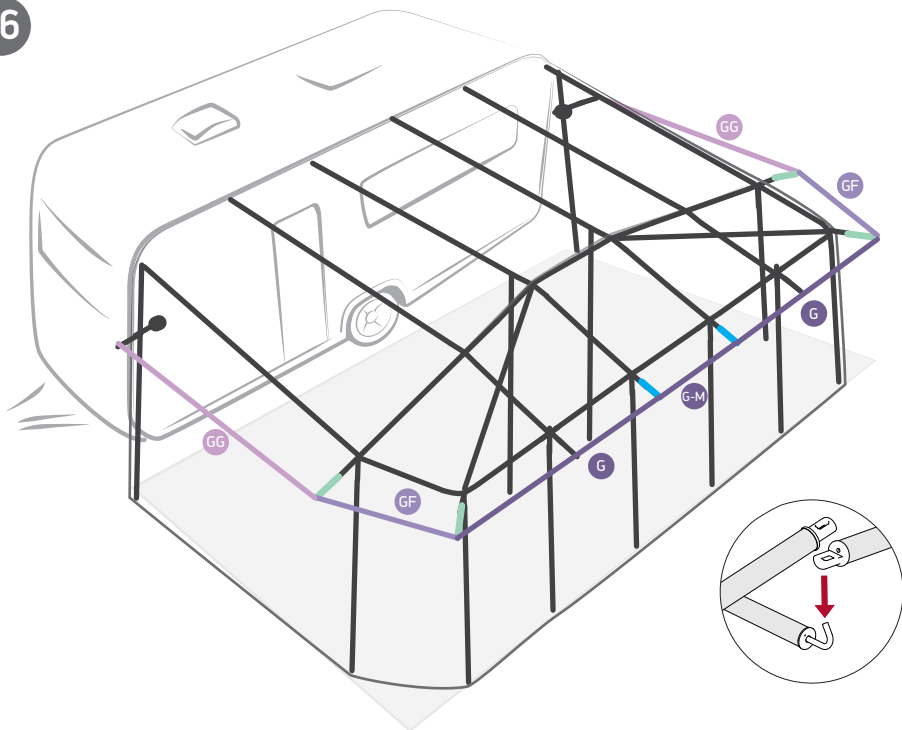

17

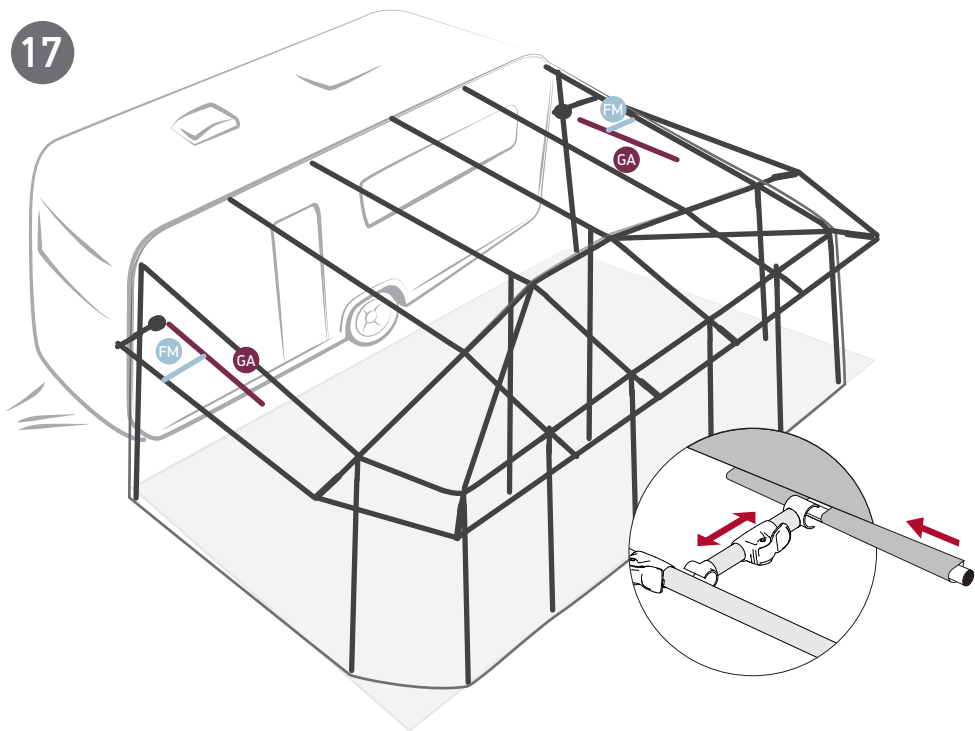

18

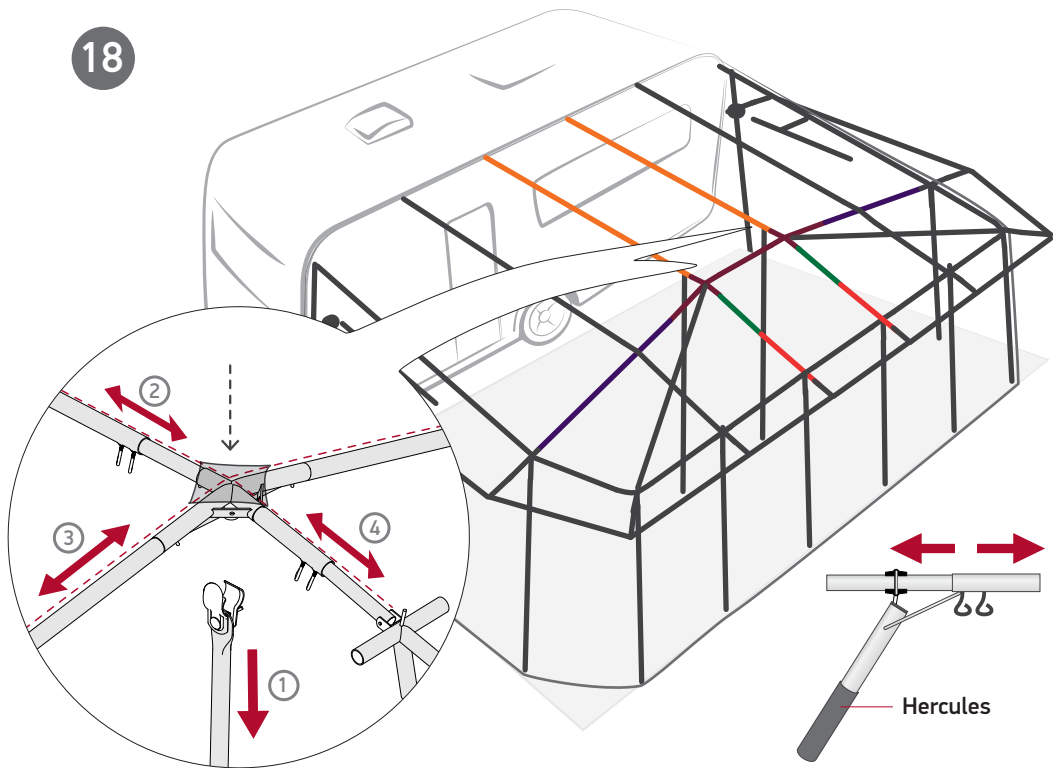

19

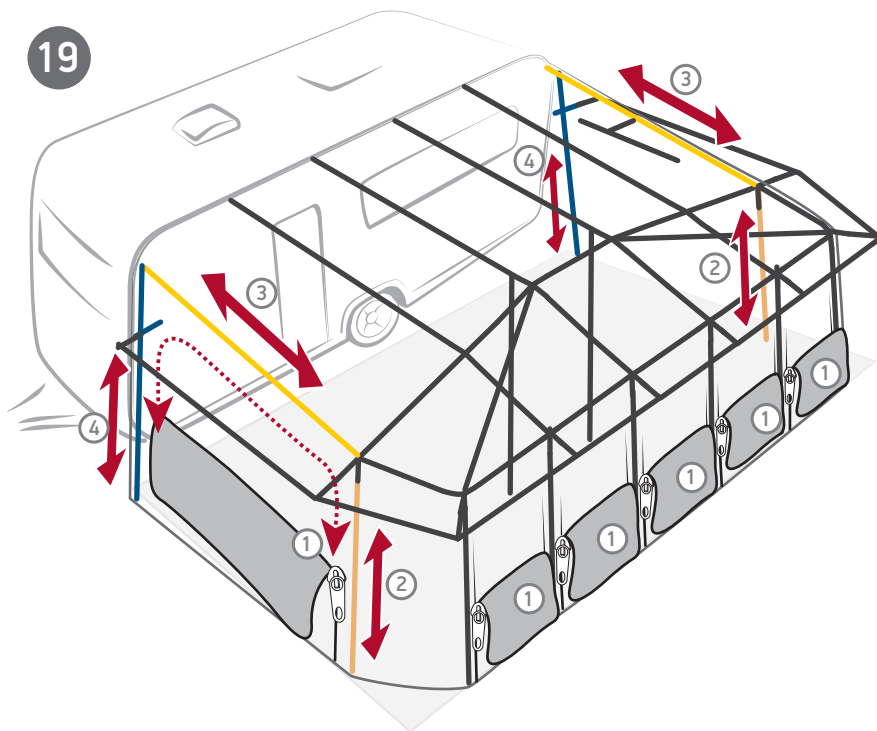

20

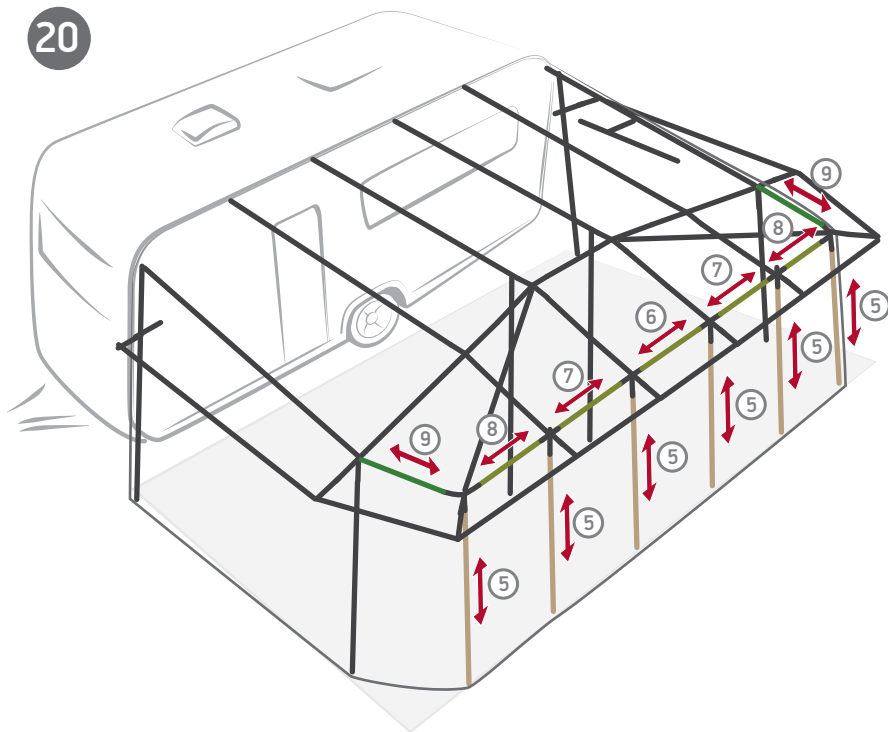

21

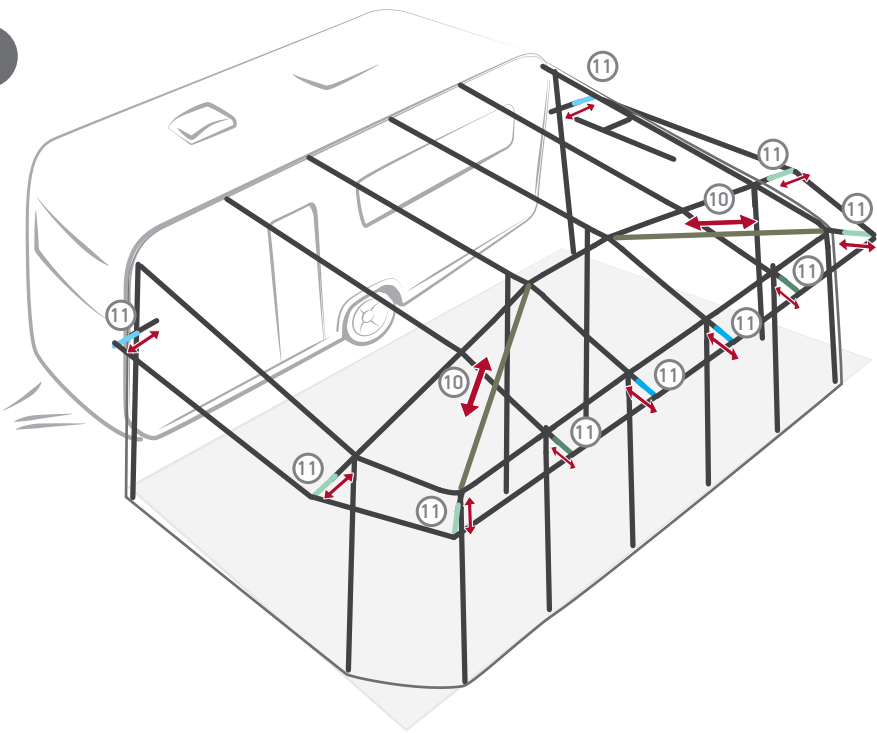

22

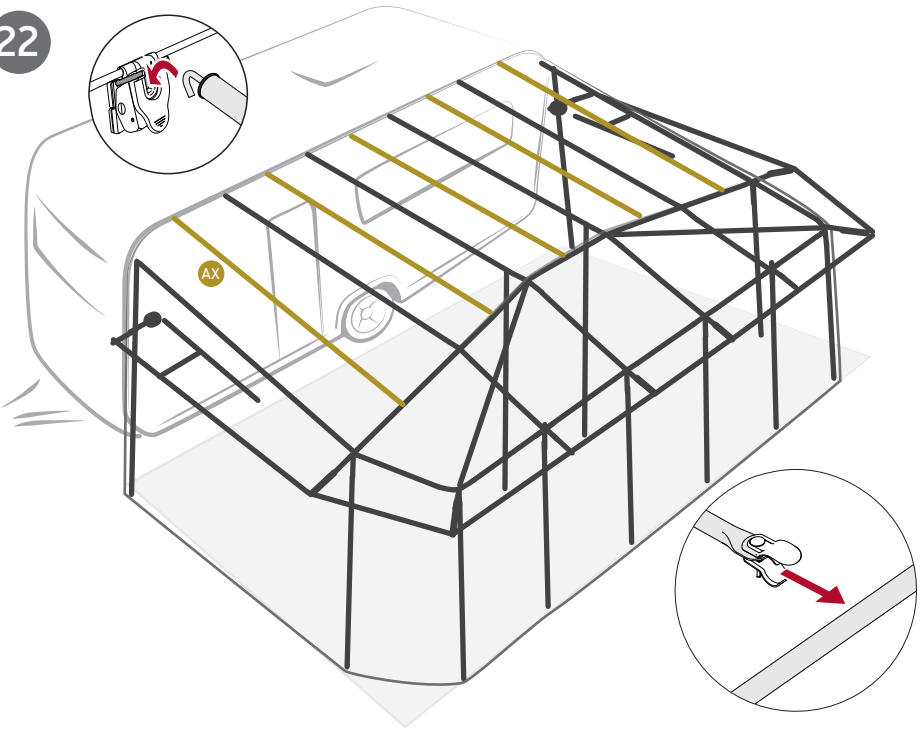

23

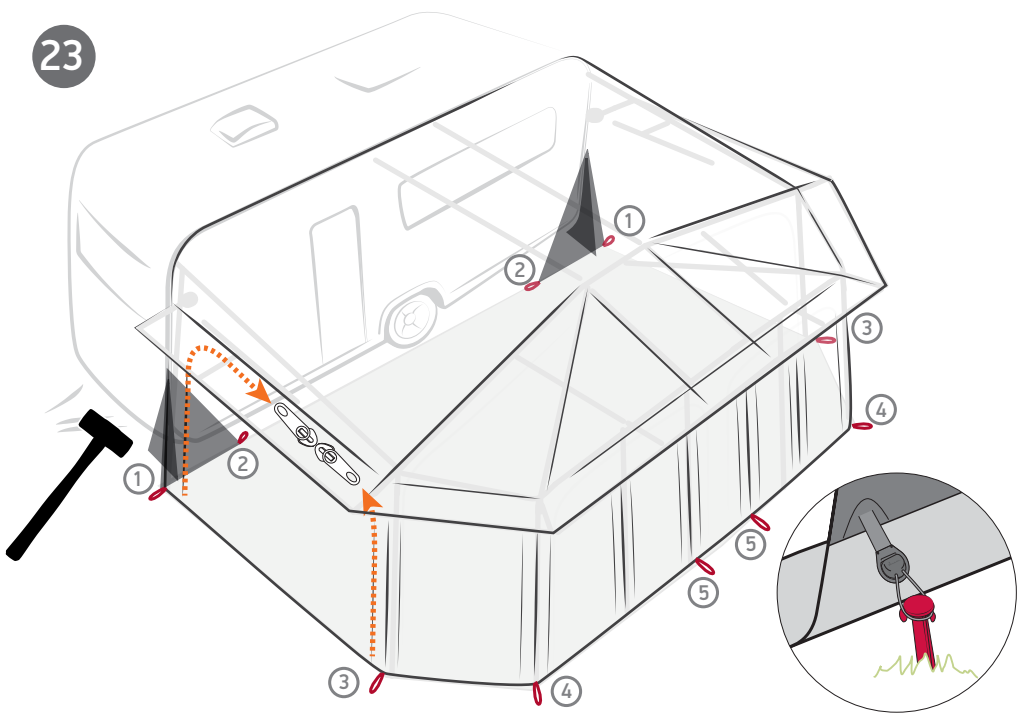

24

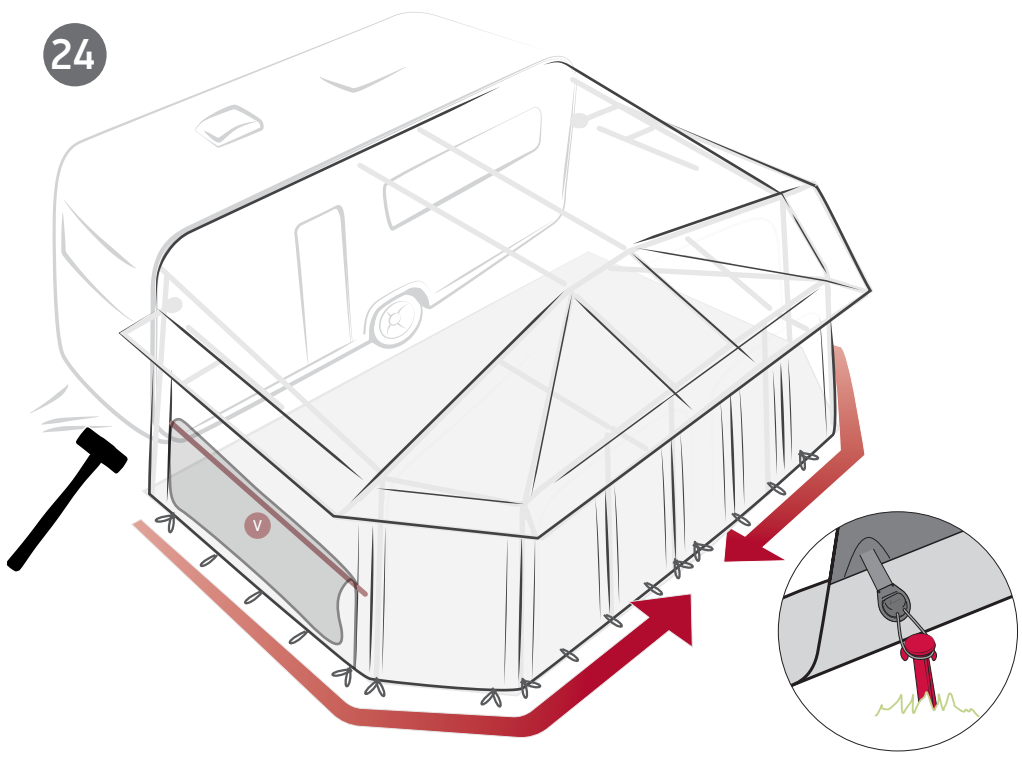

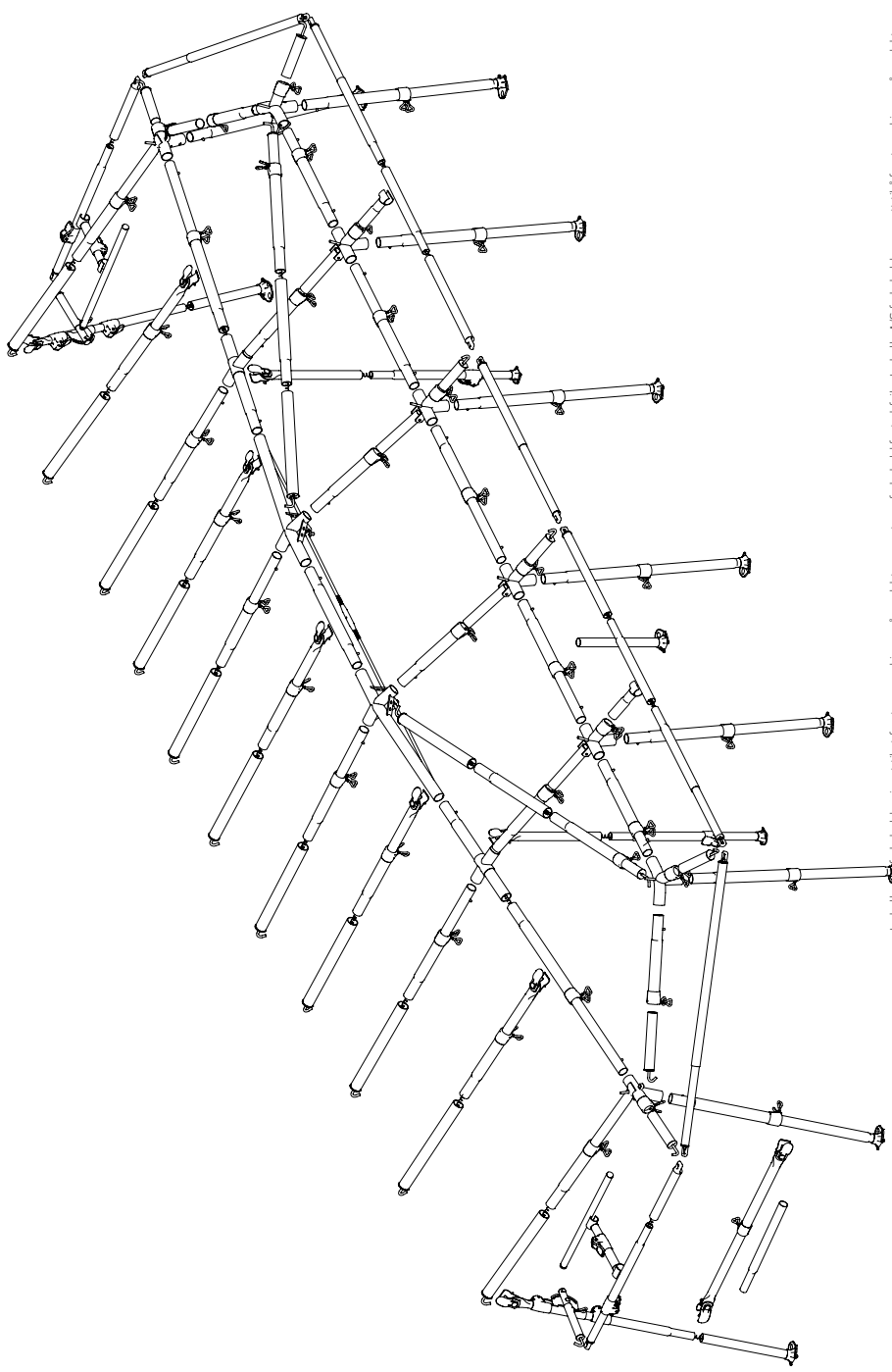

Isabella A/S forbeholder sig ret til at foretage ændringer på produktene og tager forbehold for trykfejl. • Isabella A/S forbeholder sig ret til å foreta endringer på produktene og tar forbehold for trykfeil. • Isabella A/S reserves the right to make changes on the products without notice and can accept no responsibility for discrepancies between this information and subsequent models. • Isabella A/S behält sich das Recht vor Änderungen an den Produkten vorzunehmen. Druckfehler sind vorbehalten. • Isabella A/S behoudt zich het recht voor om tussentijdse wijzigingen aan te brengen aan de producten. Voor drukfouten zijn wij niet aansprakelijk. • Isabella A/S förbehåller sig rätten till ändringar i programmet och reserverar sig även för tryckfel. • Isabella A/S se réserve le droit d'apporter des modifications aux produits, et n'est pas responsable des anomalies entre cette information et les modèles suivants. Isabella A/S pidättaa oikeuden tehdä muutoksia ilman eräkkölmotustusta, eikä voi hyväksyä mitään vastuuta näiden tietojen ja uudempimallien erojen vallita.